



# SPONGE CUTTING

专业海绵切割设备服务商



扫码关注公众号了解更多动态

[www.xinmeiteng.cn](http://www.xinmeiteng.cn)



青岛新美腾海绵机械制造有限公司  
Qingdao Xinmei sponge Machinery Manufacturing Co., Ltd.

电话: 0532-87755602 0532-8776 0291  
手机: 13608963598 18724721198  
13606481969 18661656953

邮箱: info@qd-xinmei.com 13608963598@163.com  
地址: 山东省青岛市城阳区京口社区京口工业园1180号东南  
网址: www.xinmeiteng.cn

TEL: 0532-87755602 0532-8776 0291  
Phone: 13608963598 18724721198  
13606481969 18661656953

E-mail: info@qd-xinmei.com 13608963598@163.com  
ADD: Chengyang District, Qingdao, China  
Web: www.xinmeiteng.cn



青岛新美腾海绵机械制造有限公司  
Qingdao Xinmei sponge Machinery Manufacturing Co., Ltd.



# 企业简介 COMPANY PROFILE

青岛新美腾海绵机械制造有限公司创立于 2000 年，是一家专业生产海绵切割加工设备的高新技术企业。

十余年来，公司坚持创新驱动发展，以客户、市场为导向，专注自主创新体系，致力于为全球客户提供卓越的产品和服务。主要产品有：切割、异形切割、发泡、再生、复合、粉碎、自动化等十余个系列，50 余个品种产品。公司拥有国内外顶级加工设备 20 余台，设备投资 1000 余万元，加工精度达到国际先进水平。同时汲取国际先进的管理机制，产品均已通过 ISO9001、2000 国际质量管理体系认证和 CE 认证，并荣获青岛市专精特新中小企业殊荣。

公司始终秉承“质量求生存、信誉求发展”的经营理念，以高标准、严要求把控产品品质，得到了社会的认可，产品畅销全球并出口欧洲、美洲、亚洲、大洋洲、非洲等地区。公司将不断为合作伙伴提供更加完美的解决方案，更加优质的产品，创造更多的价值！

Qingdao Xinmeiteng Sponge Machinery Manufacturing Co., Ltd. was founded in 2000, is a professional production of sponge cutting processing equipment of high-tech enterprises.

For more than ten years, the company has adhered to innovation-driven development, customer-oriented and market-oriented, focused on independent innovation system, and committed to providing excellent products and services for global customers. The main products are: cutting, profiled cutting, foaming, regenerative compound, crushing, automation and other more than 10 series, more than 50 varieties of products. The company has more than 20 sets of domestic and foreign top processing equipment, equipment investment of more than 10 million yuan, processing accuracy reaches the international advanced level. At the same time to absorb the international advanced management mechanism, the products have passed the ISO9001, 2000 international quality management system certification and CE certification, and won the Qingdao special special small and medium-sized enterprise award.

The company has always been adhering to the "quality of survival, credibility and development" business philosophy, with high standards, strict requirements to control product quality, has been recognized by the society, products sold all over the world and exported to Europe, America, Asia, Oceania, Africa and other regions. The company will continue to provide partners with more perfect solutions, more quality products, and create more value!



## TDPB-1900 高端数控圆切机 TDPB-1900 High-end CNC circular cutting machine



机身全钢板，重量大稳定性高。轮子采用合金钢，硬度高达 HRC60 以上，耐磨损，使用寿命可达十年以上。刀板采用高速合金钢，硬度达到 HRC60°，使用寿命可达八年以上。顶刀装置采用先进技术，可以自动顶刀，也可单个手动微调。前海绵托辊可以自动上升，无需人工操作，尾部切割更精准。轮子随刀带磨损自动向前移动，保持每个顶刀接触面受力均匀。数控系统采用全套西门子系统，稳定可靠，切割精度高，切割速度快。

Fuselage full steel plate, large weight and high stability. Wheels made of alloy steel, hardness up to HRC60 or more, wear resistance, service life of more than ten years. The cutter plate is made of high-speed alloy steel, the hardness reaches HRC60°, and the service life can reach more than eight years. The tool jacking device uses advanced technology and can be automatically jacked or manually fine-tuned individually. The front sponge roller can be lifted automatically without manual operation, and the tail cut is more accurate. The wheels move forward automatically with the wear of the knife belt, keeping the force on each tip contact surface uniform. CNC system adopts a full set of Siemens system, stable and reliable, cutting precision, high cutting speed.



切割宽度 Cutting width	500-2300mm
切割速度 Cutting speed	160m/min(无刀痕)
切割直径 Cutting diameter	20-1500mm
切割厚度 Cutting thickness	0.5-30mm
切割精度 Cutting accuracy	±0.05mm
电机功率 Motor power	13.16kw
电机重量 Motor weight	4000kg
外形尺寸(长×宽×高) Overall dimension(L×W×H)	5000×2500×2000mm

## TDB-2200 高端自动平切机 TDB-2200 high-end automatic flat cutting machine



本机采用全伺服电机控制，切割精度高，切割速度快，把块状海绵切成片状，便于其他设备加工生产，与其他机器的不同点在于增加了自动磨刀、自动顶刀，磨刀室增加了吹气清洁功能和照明装置，用于 PU 海绵加工行业。

The machine adopts full servo motor control, high cutting precision, fast cutting speed, the massive sponge cut into sheets, easy to other equipment processing and production, the difference with other machines is that the increase of automatic sharpening, automatic top knife, sharpening room increases the air cleaning function and lighting device, in the PU sponge processing industry.



切割泡体尺寸Cutttable bubble size (长×宽×高)	3000×2200×1250mm
切割厚度 Cutting thickness	0.5-70mm
切割厚度误差Cutting thickness error	0.5-2mm <±0.05
总功率Motor power	23kw
机器重量 Machine weight	6000kg
外形尺寸Overall dimension (长×宽×高)	8300×6200×2500mm

## TDPA-2300数控海绵圆切机

TDPA-2300CNC sponge round cutter



本机采用国内先进的数控触摸屏装置,该装置可以直接通过输入数字来控制切割厚度,不用交换齿轮或者更换齿轮,与传统的圆切机相比,它具有切割厚度更薄,切割精度更高,切割速度更快,机器的故障更少的优点,大大提高了产品的质量和工作效率。

This machine adopts domestic advanced CNC touch screen device, the device can be directly through the input of digital to control the cutting thickness, without switching gears or replacing gears, compared with the traditional round cutting machine, it has the advantages of thinner cutting thickness, higher cutting precision, faster cutting speed, less machine failure, greatly improve the quality of products and work efficiency.

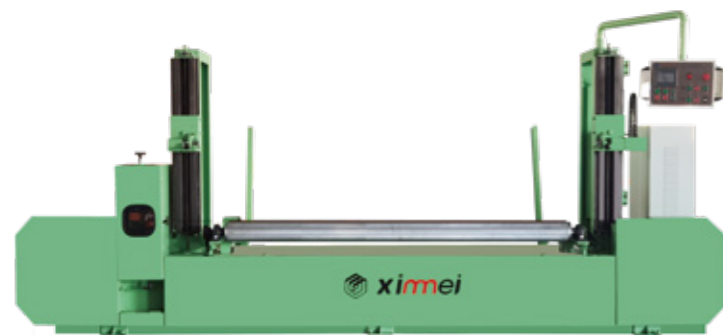

切割宽度 Cutting width	500-3000mm
切割速度 Cutting speed	0-130m/min(无刀痕)
切割直径 Cutting diameter	20-1500mm
切割厚度 Cutting thickness	1-30mm
切割精度 Cutting accuracy	±0.05mm
电机功率 Motor power	8.69kw
机器重量 Machine weight	2000kg
外形尺寸(长×宽×高) Overall dimension(L×W×H)	5000×2500×2000mm

## TDPF-03 全自动海绵立切机

TDPF-03 Automatic sponge vertical cutting machine



本机主要用于 PU 海绵, EVA, PE, EPE 等材料的精加工, 主要把整张海绵、PE、EVA、EPE 等材料, 切割成所需要大小不等的方形或长方形尺寸, 在触摸屏上输入所需要的长宽尺寸, 就能一次性不停机完成切割所需要的尺寸, 切割精度高, 刀带使用寿命长, 操作简单, 切割不需要 CAD 绘图, 做到省工省时, 效率高。

This machine is mainly used for finishing PU sponge, EVA, PE, EPE and other materials, mainly the whole sponge, PE, EVA, EPE and other materials, cut into the required size of the square or rectangular size, input the required length and width size on the touch screen, you can complete the required size without stopping at one time, high cutting precision, long service life of the knife belt, Simple operation, cutting does not require CAD drawing, saving labor and time, high efficiency.



可切泡尺寸(长×宽×高) Cuttable bubble size(L×W×H)	3000×2200×1250mm
工作台尺寸(长×宽) Table size (L×W)	7000×2300mm
切割速度 Cutting speed	0-50m/min
切割误差(长×宽) Cutting error (L×W)	±0.5mm, ±0.5mm
电机功率 Motor power	7kw
机器重量 Machine weight	4000kg
外形尺寸(长×宽) Overall dimension (L×W)	7000×6000mm

## TDPO-2.2数控环刀切割机 (平刀)

TDPO-2.2 CNC ring cutting machine (flat knife)



微齿刀的利用避免了再磨刀,切割质量精度更高,切割速度更快。用于批量 PU 海绵、乳胶海绵的切割,适用于汽车、家具、室内装饰行业,可切割异形、片材,有很高的生产效率。

The use of the micro-tooth cutter avoids re-sharpening, and the cutting quality is more accurate and the cutting speed is faster. Used for batch PU sponge, latex sponge cutting, suitable for automotive, furniture, interior decoration industry, can cut profiled, sheet, has a high production efficiency.

切割尺寸 Cutting size	6000×2100mm
切割高度 Cutting height	1300mm
刀带行走速度 Belt travel speed	0-70m/min
加工精度 Machining accuracy	±0.5mm
最小切割半径 Minimum cutting radius	10mm
电机总功率 Total motor power	8.5kw
机器重量 Machine weight	3.5ton
外形尺寸(长×宽×高) Overall dimension(L×W×H)	8000×5000×2700mm

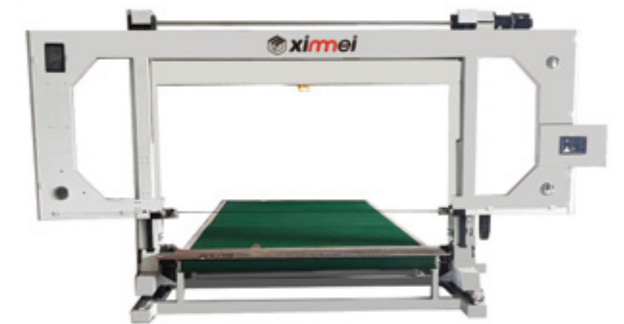

## TDPH-2.3数控环刀切割机 (竖刀)

TDPH-2.3 CNC ring cutter (vertical knife)



TDPH2.3 是环竖刀异形切割机,切割速度是振动刀切割速度的 7-8 倍,切割速度可达到 70 米 / 分钟。可切割珍珠绵、PU 海绵、PE、EVA 等材料,适用于异形切割量大的工厂。

TDPH2.3 is a ring vertical knife profiled cutting machine, the cutting speed is 7-8 times the cutting speed of the vibrating knife, and the cutting speed can reach 70 meters/min. Can cut pearl cotton, PU sponge, PE, EVA and other materials, suitable for special-shaped cutting large amount of factories.

切割尺寸 Cutting size	3000×2200mm
切割高度 Cutting height	1300mm
刀带行走速度 Belt travel speed	0-70m/min
加工精度 Machining accuracy	±0.5mm
刀带扭转角度 Belt twist Angle	±360°
压辊装置 Roll press	可选
电机总功率 Total motor power	10kw
机器重量 Machine weight	3000kg
外形尺寸(长×宽×高) Overall dimension(L×W×H)	6500×5000×3200mm



## TDP-02 全自动切边裁断机

TDP-02 automatic edge cutting machine



本机主要用于 PU 海绵, EVA, PE, EPE, XPE 等材料的精加工, 把无限长的物料先切去两边不齐的地方, 再把物料切断成所需要的长度尺寸, 收卷部分把两边裁切下来的物料卷成卷便于储存。这种机器可连接在复合机, 和切割机后面, 裁切可不用停机, 实现连续不断地裁切, 可省时省工, 提高效率。

This machine is mainly used for the finishing of PU sponge, EVA, PE, EPE, XPE and other materials. The infinite long material is first cut to the uneven place on both sides, and then the material is cut into the required length size. The winding part rolls the material cut off by the two sides into a roll for easy storage. This machine can be connected to the composite machine, and the cutting machine behind, cutting can be cut without stopping, to achieve continuous cutting, saving time and labor, improve efficiency.

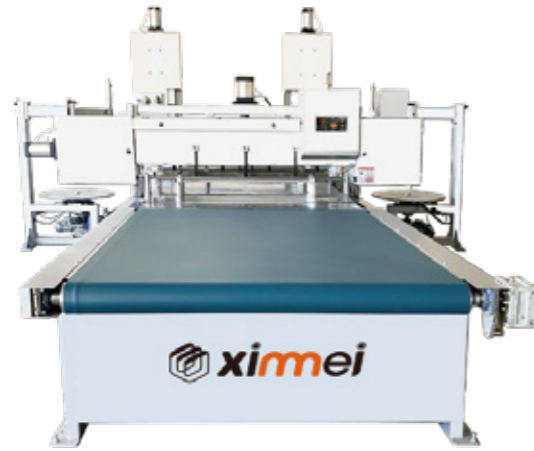

裁切宽度 Cutting width	1000-2000mm
裁切厚度 Cutting thickness	1-100mm
裁切密度 Cutting density	15-200
裁切速度 Cutting speed	1-20m/min
电机总功率 Total motor power	10kw
电机总重量 Gross motor weight	5000kg
外形尺寸(长×宽×高) Overall dimension(L×W×H)	6424×4600×2786mm

## TDP-2150 泡绵平切机(带吸风)

TDP-2150 Horizontal Cutting Machine(air draft)



这种切割机主要是把块状泡绵切成薄片, 工作台采用全自动数字控制, 并带有吸风装置, 在切割过程中增加平台与海绵的摩擦力和吸附力, 可以使海绵的切割更精准。根据需要切割的厚度和泡绵的密度, 通过触摸屏设定数值, 工作台自动往复运动切割出所需尺寸, 刀带切割角度可从 0°调到 5°。切厚绵时, 为了防止切割的泡绵滑动, 可加压辊装置, 使切割厚度更精准。

This cutting machine is mainly to cut the block foam into thin slices, the table adopts automatic digital control, and has an air suction device, in the cutting process to increase the friction and adsorption force between the platform and the sponge, which can make the sponge cutting more accurate. According to the thickness of the cutting and the density of the foam, the value is set by the touch screen, and the table automatically cuts the required size by reciprocating motion. The cutting Angle of the cutting belt can be adjusted from 0° to 5°. When cutting thick cotton, in order to prevent the cutting foam from sliding, the roller device can be pressurized to make the cutting thickness more accurate.



切割高度 Cutting height	1250mm
切绵尺寸 Cutting size (W×L)	2150×3000mm
切割厚度 Cutting width	2~300mm
功率 power	8.19kw
机器重量 Machine weight	3000kg
外形尺寸(长×宽×高) Overall dimension(L×W×H)	7000×4000×2500mm

## TDPF-01 型 双振动刀仿形切割机

TDPF-01 Double vibrating knife copying cutting machine



实现简单的三维切割和替代单件无内孔的冲床模切泡绵制品, 大大提高了三维产品的切割精度和模切加工的工作效率, 也从根本上弥补了通过旋转工作台面实现简单三维切割的同类机械无法实现薄片异型加工的弊端。

The realization of simple three-dimensional cutting and the replacement of a single piece of die-cutting foam products without internal holes by punching machine greatly improves the cutting accuracy of three-dimensional products and the efficiency of die-cutting processing, and fundamentally makes up for the disadvantages of similar machines that can not achieve simple three-dimensional cutting by rotating the workbench.

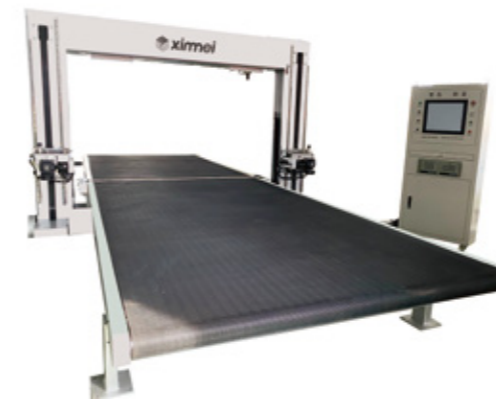

机械重量 Mechanical weight	3000kg
机械总功率 Total mechanical power	10KW
机械尺寸 Mechanical dimension	6480×3200×2300mm
块料最大尺寸 Maximum size of block material	3000×2300×1300mm
刀具参数 Tool parameter	2400×3×0.5mm 1600×3×0.5mm
伺服系统 Co-serving system	2400-2800r/min
最大加工线速度 Maximum machining line speed	0-6.3m/min
加工精度 Machining accuracy	±0.5mm
最小切割尺寸 Minimum cutting size	5mm

## TDSA-2150 软带泡绵平切机(带吸风)

TDSA-2150 SoftBelt Horizontal Cutting Machine(air draft)



这种切割机主要是把块状泡绵切成薄片, 整机采用全自动数字控制, 根据需要切割厚度, 通过触摸屏设定厚度数值, 工作台自动往复运动, 切割成所需厚度, 刀带切割角度能够从 0°调到 5°。切厚绵时, 为了防止切割的泡绵滑动, 可加压辊, 本机器是软带输送, 便于链接其他切割机器。

This cutting machine is mainly the block foam slice, the whole machine adopts automatic digital control, according to the need to cut the thickness, through the touch screen to set the thickness value, the automatic reciprocating movement of the table, cutting into the required thickness, the cutting Angle of the knife belt can be adjusted from 0° to 5°. When cutting thick cotton, in order to prevent the foam from sliding, the roller can be pressurized. This machine is a soft belt conveyor, which is easy to link other cutting machines.

切割高度 Cutting height	1300mm
切绵尺寸 Cuttingsize	3000×2000mm
切割厚度 Cutting thickness	2-300mm
切割速度 Cutting speed	0-50m/min
功率 power	17.84kw
机器重量 Machine weight	3500kg
外形尺寸(长×宽×高) Overall dimension(L×W×H)	7000×4500×2500mm



## TDPA-2150 海绵路轨平切机

### TDPA-2150 Long Sheet Horizontal Cutting Machine



本机主要用于无限长 PU 海绵的无限长切片工作，切割出的产品主要用于海绵和其他材料复合，本机采用进口变频调速控制技术，运行平稳、切割精确、生产效率高，是连续自动发泡的必备配套设备。

The machine is mainly used for the indefinite length of PU foam slicing work, the cut products are mainly used for sponge and other materials composite, the machine adopts imported frequency control technology, smooth operation, precise cutting, high production efficiency, is a necessary supporting equipment for continuous automatic foaming.



切绵宽度/Cutting width	2200mm
切片厚度/Slicethickness	1.5~70mm
电机功率/Motorpower	14.89kw
切割高度/Cuttingheight	1300mm
行走速度/Moving speed	0~60m/min
机器重量/Machineweight	2800kg
机器外形尺寸(长×宽×高) Machineexternalsize(L×W×H)	4300x2100x2200mm

## TDP-70 海绵圆盘平切机(带吸风)

### TDP-70 Disc Horizontal Cutting Machine(air draft)



本机圆盘驱动采用变频调速控制，切割厚度 PLC 触屏控制，可靠性高，切割精确。本机主要用于多个 PU 方泡绵的一次性水平切片工作，连续切割，不用退刀，生产效率更高。

The disk drive adopts frequency conversion speed control, and the cutting thickness is controlled by PLC touch screen, which has high reliability and precise cutting. This machine is mainly used for multiple PU square foam one-time horizontal slicing work, continuous cutting, no need to return the knife, higher production efficiency.

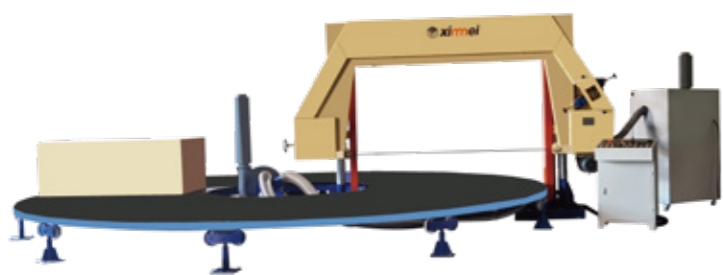

切绵尺寸 Cuttingsize	2000x3000mm
工作转盘转速 Discrotationalspeed	0~3.5r/min
电机功率 Motor power	22kw
刀带周长 Bandknifelength	10000mm
切片厚度 Cuttingthickness	2~150mm
切割高度 Cutting height	1250mm
机器重量 Machineweight	4000kg
外形尺寸(长×宽×高) Overall dimension(L×W×H)	8000x7000x2400mm

## TDP-4LS 型 全自动立切机

### TDP-4LS automatic vertical cutting machine



本机采用刀架来回移动，平台上挡板来回移动，工作台固定的形式，将海绵块夹持在两块挡板之中，可移动的切割刀架在直线导轨上作往复运动，根据所需切割宽度从而挡板左右移动，形成对海绵体等进行往返垂直切割工作。可自动切割成块状或条状，此机器还采用了伺服调速 PLC 自动控制系统，能通过控制面板自动控制切割宽度和速度以及刀架挡板的来回移动，具有自动化程度高、切割精准、操作安全、省工省时、无需人工看守。

The machine adopts the form of the tool holder moving back and forth, the baffle on the platform moving back and forth, the table is fixed, the foam block is held in two baffles, the movable cutting tool holder is reciprocated on the linear guide rail, and the baffle moves left and right according to the required cutting width to form the foam body and other vertical cutting work. It can be automatically cut into blocks or strips. The machine also uses a servo speed regulating PLC automatic control system, which can automatically control the cutting width and speed as well as the back-and-forth movement of the tool holder baffle through the control panel. It has a high degree of automation, cutting precision, operation safety, labor and time saving, and no manual guard.

内工作台尺寸/Internal table size(L×W)	2300x2400mm
外工作台尺寸 External table size(L×W)	2400x2400mm
切割海绵尺寸 Cutting sponge size(L×W×H)	2000mm×2000mm×1250mm
切割海绵厚度 Cutting sponge thickness	2-1250mm
总功率 Gross power	6.08kw
外形尺寸(长×宽×高) Overall dimension(L×W×H)	5000×2600×2500mm



## TDA-1650/2150 海绵平切机

### TDA-1650/2150 Horizontal Cutting Machine



本机采用当前最先进的进口变频调速控制技术，刀板加厚，主要用于硬泡绵及再生绵的水平切片工作。本机全自动数字控制，操作简便，切割精确。

This machine adopts the most advanced imported frequency conversion speed control technology, knife plate thickening, mainly used for hard foam and recycled cotton horizontal slicing work. The machine automatic digital control, easy to operate, precise cutting.

切片厚度 Slicethickness	1~100mm
电机功率 Motorpower	7.94kw
切割尺寸(宽×长) Cuttingsize(W×L)	1650×2000mm 2150×3000mm
工作台移动速度 Worktablemoving speed	0~30m/min
机器重量 Machine weight	2600kg
外形尺寸(长×宽×高) Overall dimension(L×W×H)	8000×4200×2400mm



## TDP-4L 泡绵直切机

### TDP-4L Vertical Cutting Machine



本机主要用于 PU 泡绵垂直切块和切条工作，同时可加工各种纸类 EVA、PE、纸板及珍珠绵。

This machine is mainly used for PU foam vertical cutting and cutting, and can process all kinds of paper EVA, PE, cardboard and pearl wool.

型号 Model number	标准 Normal	加大 Oversize
内工作台尺寸 Inner table dimensions(L×W)	2500x1320mm	2500x1630mm
外工作台尺寸 External table size(L×W)	2500x1800mm	2500x2000mm
切割高度 Cutting height	1250mm	1250mm
电机功率 Motor power	2.38kw	2.38kw
机器重量 Machine weight	1800kg	1900kg
外形尺寸(长×宽×高) Overall dimension(L×W×H)	4000x4000x2500mm	4300x4000x2500mm



## TDP-45 型角度切割机

### TDP-45 Angle cutting machine



这种切割机可以把 PU 海绵和其他橡塑材料四边切成斜坡，用于家具和纺织行业特殊要求加工，切割成角度 0~45° 的斜边。

This cutting machine can cut the four sides of PU sponge and other rubber and plastic materials into slopes for the special requirements of furniture and textile industry processing, cutting into an Angle of 0~45° beveled edge.

切割角度 Cutting Angle	0-45°
电机功率 Motor power	1.68kw
机器重量 Machine weight	1000kg
外形尺寸(长×宽×高) Overall dimension(L×W×H)	2000×1000×2000mm



## TDA-3L 泡绵直切机

### TDA-3L Vertical Cutting Machine



本机主要用于 PU 泡绵垂直切块和切条工作。本机同时可加工各种纸类 EVA、PE、纸板及珍珠绵。

This machine is mainly used for PU foam vertical cutting and cutting work. This machine can also process all kinds of paper EVA, PE, cardboard and pearl wool.

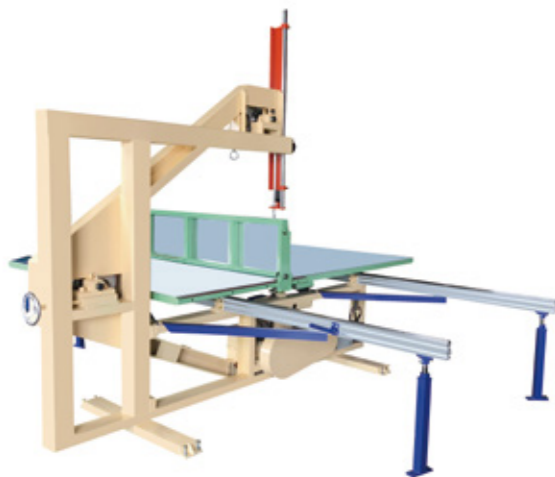

型号 Model number	标准 Normal	加大 Oversize
内工作台尺寸 Inner table dimensions	1320×2500mm	1650×2500mm
外工作台尺寸 External table size	1800×2500mm	2000×2500mm
切割高度 Cutting height	1250mm	1250mm
刀带长度 Belt length	6900mm	7600mm
电机功率 Motor power	1.68kw	1.68kw
机器重量 Machine weight	1000kg	1100kg
外形尺寸(长×宽×高) Overall dimension(L×W×H)	4000x4000x2500mm	4350x4000x2500mm

## TDP-90 角度切割机

### TDP-90 Angle cutting machine



这种切割机可以把 PU 海绵或橡塑产品切成斜坡，用于家具和其他行业的特殊要求加工，切割成 0-45° 的斜坡。

This cutting machine can cut PU sponge or rubber products into slopes for special requirements of furniture and other industries, cutting into 0-45° slopes.

切割角度/Cutting angle	0-45°
电机功率/Motor power	1.68kw
机器重量/Machine weight	1800kg
机器外形尺寸(长×宽×高) Machine external size(L×W×H)	4000×4000×2500mm



## TDC-01 泡沫裁断机

TDC-01 Cutting-Off Machine



本裁断机适合把发泡出来的长海绵裁断，一般与连续发泡线配套使用；裁断的长度由数字控制，很精准。

The cutting machine is suitable for cutting the foaming long foam, and is generally used with continuous foaming line; The length of the cut is controlled by numbers, very precise.



切割高度 Cutting height	1300mm
电机功率 Motor power	6.14kw
切割宽度 Cutting width	2300mm
机器重量 Machine weight	1000kg
外形尺寸(长×宽×高) Overall dimension(L×W×H)	4200×1300×3800mm

## TDPH-01 自动码垛机

TDPH-01 Automatic palletizer



本机主要用于海绵、EVA、PE 等各种片材的自动码垛堆高，本机全部采用伺服电机，运行平稳，码垛整齐，是自动切割机器的配套产品，节省人工，效率更高。

This machine is mainly used for automatic sponge, EVA, PE and other sheets stacking high, the machine all use servo motor, smooth running, palletizing neatly, is a matching product of automatic cutting machine, saving people work, more efficient.



码垛物料尺寸 Palletizing material size	3000×2000mm
码垛速度 Palletizing speed	60m/min
码垛高度 Palletizing height	2800mm
电机总功率 Total motor power	17.2kw
机器重量 Machine weight	8500kg
外形尺寸(长×宽×高) Overall dimension(L×W×H)	10000×2100×3600mm

## C516 防火型集尘器

C516 fireproof dust collector



C516 防火型集尘器是新美公司自主研发的一款高端磨刀用的吸尘器，它的优点是采用不锈钢滤芯，防火阻燃，配消音器降低了噪音，安装的旋风分离器可以省去经常清洗滤芯的麻烦，节省人工。是圆切机、平切机、立切机磨刀必备产品。有利于车间环境清洁干净。

C516 fireproof dust collector is a high-end sharpener vacuum cleaner independently developed by Xinmei company, its advantage is the use of stainless steel filter element, fire-proof and flame retardant, with silencer to reduce the noise, the installed cyclone separator can save the trouble of often cleaning the filter element, save labor. Round cutting machine, flat cutting machine, vertical cutting machine sharpening necessary products. Conducive to a clean workshop environment. center of the sponge, sponge waste reduction, sponge utilization rate, no manual, automatic punching bar save time and effort.



防火等级 Fire rating	A级（不燃） Level A(non-combustible)
不锈钢滤芯 Stainless steel filter element	2个 two 1500目 1500 mesh
旋风分离器 Cyclone separator	1个 one
电机功率 Motor power	1.5kw/2.2kw
电压 voltage	220v/380v
重量 weight	200kg
外形尺寸（长×宽×高） Overall dimension (L×W×H)	1200*650*1750mm

## TDP-16 手工发泡机

TDP-16 Manual Foaming Machine



这种发泡机采用变频调速控制装置。把原料放在发泡桶里进行混合搅拌，通过高速与低速独立调速控制，混合速度每分钟 0 到 3000 转。

This foaming machine adopts frequency conversion control device. Put the raw materials into the foaming tank and mix it separately controlled by high speed and low speed. The mixing speed is from 0 to 3000 rpm.



转速 Rotational speed	0~1500rpm
日生产量 Output/day	6~8ton
机器重量 Machine weight	600kg
发泡桶容量 Foaming tank's capacity	80~150kg
电机功率 Motor power	7.5/11kw
机器外形尺寸(长×宽×高) Machine external size(L×W×H)	1200 x 600 x 1000mm

## TDA-2000 泡绵压形切割机

### TDA-2000 Profile Cutting Machine



本机为压形切割机械, 主要将泡绵压成波浪状绵。适用于电子、精密仪器、汽车坐垫、保健用品, 床垫, 以及水果包装等包装用途。

This machine is a press cutting machine, which mainly presses foam into wavy foam. It is suitable for electronics, precision instruments, car seat cushions, health products, mattresses, and fruit packaging.



最大压形宽度 Maxprofilingwidth	2000mm
压形轴转速 Profiling axletree rotational speed	0~15r/min
刀带长度 Bandknifelength	9400mm
机器重量 Machineweight	3800kg
最大压形深度 Maxprofilingdepth	30mm
切割速度 Cuttingspeed	0~25m/min
电机功率 Motorpower	9.94kw
外形尺寸(长×宽×高) Overall dimension(L×W×H)	4800×4300×1400mm

## TDAF立式网带复合机

### TDAF Mesh-belt Laminating Machine



本机器用于 PU 海绵、EVA、PE 与布料、革、皮、无纺布、网等产品的上胶复合, 适用于制鞋、服装、装潢、汽车、地垫等行业, 具有平整无皱、粘合牢固等特点。

This machine is used for PU sponge, EVA, PE and fabric, leather, leather, non-woven fabric, net and other products on the glue compound, suitable for shoes, clothing, decoration, automobile, floor mat and other industries, with smooth wrinkle-free, solid adhesion and other characteristics.

型号 Model number	标准 Normal	加大 Oversize
幅宽 Laminating width	2000mm	2200mm
烘筒尺寸(长×直径) Sheet size(L×dia.)	1200×2200mm	1500×2400mm
复合长度 Compound length	3~15m/min	3~18m/min
电机功率 Motor power	32.55kw	42.55kw
机器重量 Machine weight	3500kg	4000kg
外形尺寸(长×宽×高) Overall dimension(L×W×H)	6800×2550×2430mm	6850×4250×2430mm



## TDP-4L泡绵直切机

### TDP-4L Vertical Cutting Machine



本机主要用于泡绵垂直切片及泡绵成型的切片工作, 同时可加工各种纸类 EVA、PE、纸板及珍珠绵。

This machine is mainly used for cutting the foam vertically into slice. The machine can also manufacture various EVA, PE, pearl rubber, etc.

型号 Model	标准 (Normal)	加大 (Oversize)
内工作台尺寸(宽×长) Inner worktable size(W×L)	1320×2500mm	1650 ×2500mm
外工作台尺寸(宽×长) Outer worktable size(W×L)	1800×2500mm	2000×2500mm
切割高度 Cutting height	1250mm	1250mm
刀带长度 Bandknife length	8000mm	9000mm
电机功率 Motor power	1.68kw	1.68kw
机器重量 Machine weight	1800kg	1900kg
机器外形尺寸(长×宽×高) Machine external Size(L×W×H)	4000×4000×2400mm	4350×4000×2400mm



## TDL-2200冷粘复合机

### TDL-2200 Non-heating Laminating Machine



本机器用于 PU 海绵、EVA、PE 与布料、革、皮、无纺布、网等产品的上胶复合, 适用于制鞋、服装、装潢、汽车、地垫等行业。本机具有冷复合, 不用加温, 具有省电降低成本之功效, 平整无皱、粘合牢固等优点。

This machine is used for PU sponge, EVA, PE and fabric, leather, leather, non-woven fabric, net and other products, suitable for shoes, clothing, decoration, automobile, floor mat and other industries. This machine has the advantages of cold composite, no heating, power saving and cost reduction, flat and wrinkle-free, solid adhesion and so on.

幅宽 Laminating width	2000-2200mm
机器重量 Machine weight	3000kg
复合速度 Recombination velocity	10~50m/min
电机功率 Motor power	8kw
外形尺寸(长×宽×高) Overall dimension(L×W×H)	7800×2200×2000mm





## TDP-2650型 水平自动连续发泡生产线

TDP-2650 Horizontal Continuously Automatic Foaming Product Line



本设备主要适用于 8 ~ 120 kg / m<sup>3</sup> 密度的聚氨酯泡沫生产, 具有自动化程度高、生产成本低、操作简便等优点, 是从事生产汽车、家私、鞋材、文胸、电子、制衣以及汽车工业用泡沫最为理想的生产设备。

This equipment is mainly suitable for 8 ~ 120 kg / m<sup>3</sup> density of polyurethane foam production, with a high degree of automation, low production cost, easy operation and other advantages, is engaged in the production of automotive, furniture, footwear, bra, electronics, clothing and automotive industry foam with the most ideal production equipment.



烘箱长度/Ovenlength	18m
侧板调节宽度/Sidepaneladjustment	930-2300mm
连接传送带长度/Conveyerlength	25m
连接传送带速度/width	2-6.5m/min
发泡高度/Foamingheight	0.4-1250m
混合头电机功率/Conveyer speed	37kw
总功率/Totalpower	130kw
生产能力/Agitator's motor power	8000~15000 (kg/h)
机器重量/Machine weight	30000kg
机器外形尺寸(长x宽x高) Machine external size(LxWxH)	6200x450x370mm

## TDP-1500型 圆泡垂直连续发泡机

TDP-1500 Vertical Continuously Cylinder Foam Foaming Machine



本设备主要适用于 8~ 50kg / m<sup>3</sup> 密度的软体聚氨酯泡沫生产, 具有自动化程度高、生产成本低、操作简便等优点, 是从事生产家私、鞋材、文胸、电子、制衣以及汽车工业用泡沫最为理想的生产设备。

This machine is mostly used for producing sof PUfoam(density is about 8~50kg/m<sup>3</sup>). It has many merits such as the high automation level, the low-cost production, the simple operation and so on. It is the most desirable equipment to manufacture products of foam rubber in furniture, shoes, bra, electronic products, clothes and automobile industry.

发泡直径 Foaming Diameter	Φ1.2-1.5m
提升速度 Lifting speed	0-3m/min
发泡头流量 Foaming flow	90L/min
发泡密度 Foaming density	10-50m <sup>3</sup>
发泡头转速 Rotational speed	3000-5000rpm
生产能力 Production capacity	3000kg/h
总功率 Total power (kw)	56kw
机器重量 Machine weight (kg)	12000kg
机器外形尺寸(长x宽x高) Machine external size(LxWxH)	4000x6000x8500mm(不包括料罐和控制部分) Tanks and controls are not included)



## TDP-63自动打孔机

TDP-63 Automatic hole punch



本机为泡绵圆切机的配套设备, 自动实现圆形泡绵的中间钻孔加工。

This machine is the auxiliary equipment of the round foam cutting machine, which automatically realizes the middle drilling of the round foam.

钻孔直径 Hole diameter	45~80mm
主轴转速 Spindle speed	230rpm/min
钻孔长度 Borehole length	500-2300mm
电机功率 Motor power	3kw
机器重量 Machine weight	1200kg
外形尺寸(长x宽x高) Overall dimensions(LxWxH)	6000x1500x2500mm



## C518型打孔穿杠一体机

C518 Punching and piercing machine



本机主要配套垂直圆泡发泡机和圆切机使用, 把圆泡中心打上孔, 便于圆切机切割无限长海绵。C518型打孔机的优点在于它比任何一款打孔机打孔精准, 采用三个方向抱夹, 自动找正海绵中心, 海绵废料减少, 海绵利用率高, 穿杠不用人工, 自动穿杠省时省力。

This machine is mainly used with vertical foam foaming machine and circular cutting machine. The center of the circular foam is punched with a hole, which is convenient for the circular cutting machine to cut the infinite long sponge. The advantage of C518 type punching machine is that it is more accurate than any type of punching machine, using three directions to hold the clamp, automatically find the center of the sponge, sponge waste reduction, sponge utilization rate, no manual, automatic punching bar save time and effort.



钻孔直径 Hole diameter	50-80mm
钻孔长度 Borehole length	500-2300mm
海绵直径 Sponge diameter	1200-1500mm
电机功率 Motor power	3.7kw
机器重量 Machine weight	2000kg
外形尺寸(长x宽x高) Overall dimension(LxWxH)	6500*2000*2500mm

## TDPB-A 再生方泡发泡机

TDPB-A Regenerative square foam foaming machine



生产出的产品密度均匀,突破了以往再生发泡机,发泡上下密度误差太大的弊端。本机主要把粉碎好的泡绵、橡胶、EVA、EPE 等碎原料用胶水混合搅拌、加压,加蒸汽成型或自然固化。生产出的产品经过切割加工后可用于健身器材、体操垫、牛床垫、汽车内饰、鞋材、地垫、装潢等行业,用途广泛,节省成本。

The product density is uniform, breaking through the previous regenerative foaming machine, foam density error is too large. This machine mainly mixes the crushed foam, rubber, EVA, EPE and other crushed raw materials with glue, stirring, pressurizing, adding steam forming or natural curing. After cutting and processing, the products can be used in fitness equipment, gymnastics mat, cow mattress, automotive interior, shoe material, floor mat, decoration and other industries, with a wide range of uses and cost savings.



发泡尺寸(长×宽×高) Foam size (L×W×H)	2100×(1100-2000)×(600-1200)mm
发泡密度 Foam density	50-300
生产能力 Productive capacity	3模/小时
密度误差 Density error	±5
电机功率 Motor power	46kw
机器重量 Machine weight	16ton
外形尺寸(长×宽×高) Overall dimension(L×W×H)	7695×6235×9407mm

## TDPF-04再生圆泡三连发流水线

TDPF-04 Regenerated round bubble triple hair line



本机主要用于 PU 海绵,橡胶,PE,EVA,EPE 等材料的废旧利用,把海绵、PE、EVA、EPE 的边角料粉碎、加入胶水搅拌、再加压成型。用蒸汽或自然干燥把胶水和碎料粘合成圆泡,再用圆切机切割成无限长的薄片,复合上 PE 膜或布料。用于地毯下面铺垫或地板垫及鞋材等用途。

This machine is mainly used for PU sponge, rubber, PE,EVA,EPE and other materials waste utilization, the sponge, PE,EVA,EPE scraps crushed, add glue stirring, then pressure molding. Use steam or natural drying glue and scrap material bonded into a round bubble, and then cut into an infinite long sheet with a round cutter, and compound PE film or cloth. It is used for bedding under carpets or floor MATS and shoe materials.



发泡尺寸(直径×长) Foam size	(φ100-1300)×(L1200-2200)mm
搅拌箱容积 Mixing tank volume	15m <sup>3</sup>
生产能力 Productive capacity	9 (die/h)
生产密度 Production density	50-300 kg/m <sup>3</sup>
电机总功率 Total motor power	75kw
机器重量 Machine weight	60000kg
外形尺寸(长×宽×高) Overall dimensions(L×W×H)	9770×6683×13305mm

## 海绵撕碎机

Sponge shredding machine



本机主要用于将紧密打包的整包 PU 海绵撕碎成小块海绵,再经过粉碎机粉碎。与再生海绵生产线配套做成再生海绵;或粉碎后做填充料。本机功率强大,生产效率高。

This machine is mainly used to shred the whole package of tightly packed PU sponge into small pieces, and then crushed by the crusher. Made of recycled sponge with recycled sponge production line; Or crushed to make filler. The machine has strong power and high production efficiency.



型号 Model number	TDP-S-7	TDP-S-8
撕碎速度 Shredding speed	2000kg/h	3000kg/h
撕碎颗粒 Shredded particle	50-100mm	50-100mm
进料口尺寸 Feed port size	1100×1050mm	1350×1400mm
电机功率 Motor power	55kw	75kw
机器重量 Machine weight	8000kg	10000kg
外形尺寸(长×宽×高) Overall dimensions(L×W×H)	2900×2300×2800mm	3200×2600×3000mm

## TDP-10再生泡绵生产线

TDP-10 Rebond Foam Product Line



本机主要把碎海绵与胶混合在一起加压,用蒸汽成型或者自然干燥。产品主要用于健身器、汽车、体育垫、家私、鞋业、牛床垫、地垫、装潢等行业。

This machine mainly mixes the broken sponge and glue together to pressure, steam forming or natural drying. Products are mainly used in fitness equipment, automobile, sports mat, furniture, shoes, cow mattress, floor mat, decoration and other industries.



搅拌容积 Stirring volume	15m <sup>3</sup>
泡体尺寸(长×宽×高)/Foaming size(L×W×H)	2100×1800×1000mm
电机功率 Motor power	33kw
外形尺寸(长×宽×高) Overall dimension(L×W×H)	4000×4000×5400mm
搅拌速度 Stirring rate	40r/min
生产能力 Productive capacity	3模/小时(3block/h)
机器重量 Machine weight	8000kg

## C519型自动打孔机

C519 automatic punching machine



本机为海绵圆切机配套,自动实现圆泡、方泡 PU 海绵中间打孔加工。主要优点为方泡、圆泡都可打孔,自动进给。

This machine is matched with the foam round cutting machine, which automatically realizes the middle punching processing of the round foam and the square foam PU sponge. The main advantage is that square bubble, round bubble can be punched, automatic feed.

钻孔直径 Hole diameter	50-80mm
钻孔长度 Borehole length	2300mm
电机功率 Motor power	4kw
机器重量 Machine weight	1500kg
外形尺寸 (长×宽×高) Overall dimensions(L×W×H)	6000×1600×2500mm



## TDB-01 打包机

TDB-01 Packing Machine



本机器主要是将大块海绵压实使其体积缩小,然后将其包装以方便运输。

This machine is mainly used to press big block foam to reduce its volumethen pack it to transport conveniently.

最大海绵尺寸 Maximum foam size	900x700x1000mm
最大行程 Maximum stroke	800mm
机器重量 Machine weight	2500kg
电机功率 Motor power	7.5kw
外形尺寸 (长×宽×高) Overall dimensions(L×W×H)	1300x11200x3000mm



## TDP-S-1/2型 海绵粉碎机

TDP-S-1/2 Crushing Machine



本机主要用于海绵边角料的粉碎后再回收利用,与再生海绵生产线配套做成再生海绵;或粉碎后做填充料。本机功率强大,出风力强,生产效率高,缺点,噪音大,故障率高。

This machine is mainly used for crushing and recycling foam scraps, and making recycled sponge with recycled sponge production line; Or crushed to make filler. The machine has strong power, strong wind power, high production efficiency, shortcomings, loud noise, high failure rate.

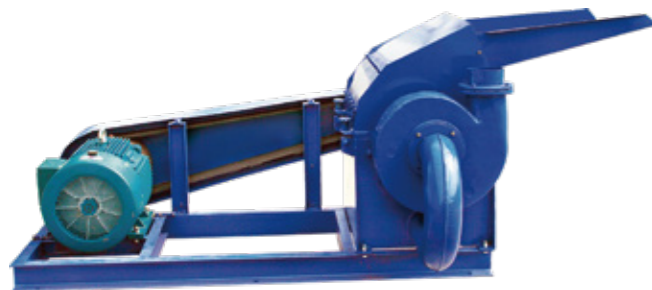

型号 Model number	TDP-S-1	TDP-S-2
破碎速度 Crushing rate	150kg/h	300kg/h
破碎粒度 Crushing size	2-30mm	2-30mm
电机功率 Motor power	15kw	30kw
机器重量 Machine weight	700kg	1000kg
外形尺寸 (长×宽×高) Overall dimensions(L×W×H)	1500×500×800mm	1800×600×1000mm

## TDP-S-4低噪音刀切粉碎机

TDP - S - 4 low noise knife grinder



本机主要用于粉碎 PU 海绵、布绵、PE、EVA、塑料和橡胶等。可和 PU 海绵再生设备配套使用, TDP-S-4 型粉碎机带有隔音降噪装置,其优点粉碎效率高,噪音小故障率低,粉碎安全。

This machine is mainly used for crushing PU sponge, cloth, PE, EVA, plastic and rubber, etc. Can be used with PU sponge regeneration equipment, TDP-S-4 crusher with sound insulation noise reduction device, its advantages of high crushing efficiency, low noise failure rate, crushing safety.

转子尺寸 (直径×长度) Rotor size	φ600×1200mm
粉碎能力(筛网φ15mm、kg/h) Crushing capacity	1200-2000kg/h
入料口宽度 Inlet width	1200mm
电机功率 Motor power	75kw
外形尺寸 (长×宽×高) Overall dimension(L×W×H)	2500×2100×2900mm
整机重量 Machine weight	5600kg

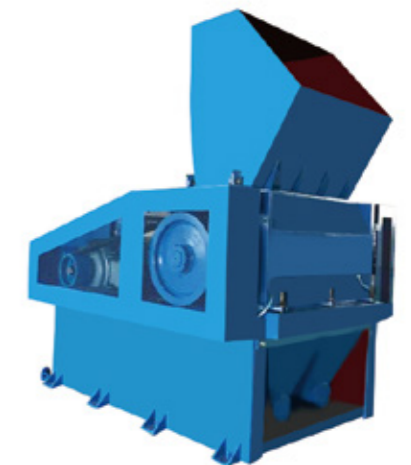

## 环切机

Ring cutting machine



主要把无限长的 PU 海绵粘接成环形, 进行不间断的切割, 这样可以极大的提高了工作效率, 海绵也减少了浪费。环切机的切割速度和精度要优于其他的 PU 泡绵的水平切割设备。

Mainly the infinite long PU sponge bonded into a ring, continuous cutting, which can greatly improve the work efficiency, sponges also reduce waste. The cutting speed and accuracy of the ring cutting machine are better than other PU foam horizontal cutting equipment.

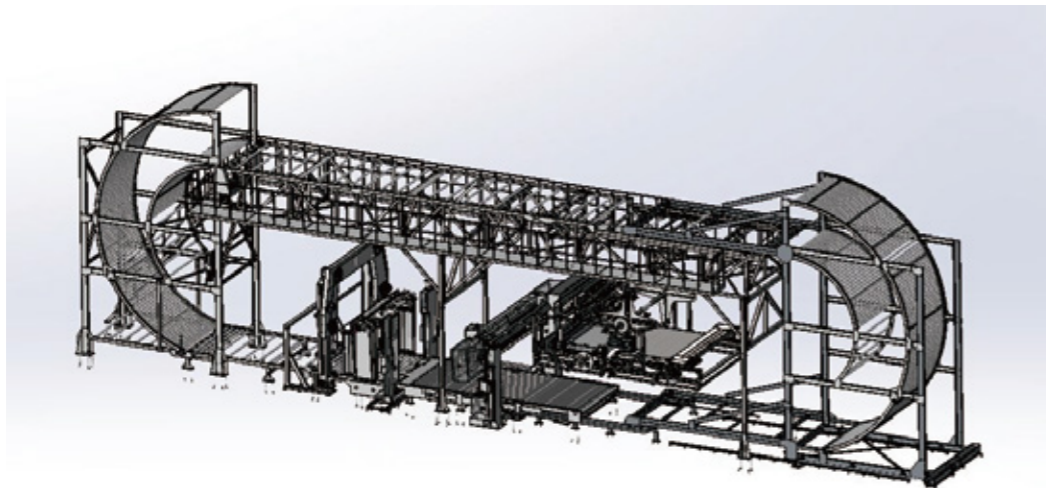

## 平切机、码垛机

Flat cutting machine, palletizer



用 PU 海绵水平切割机先把块状泡绵刨切成片状, 再通过码垛机自动堆成一定高度, 这样既省去了用人工堆垛的繁琐, 又做到了省工省时, 同时也提高了工作效率, 更便于储存和装卸。

Using a PU sponge horizontal cutting machine, the block foam is first sliced into pieces, and then automatically stacked into a certain height through a stacking machine. This not only eliminates the cumbersome manual stacking, but also saves labor and time, improves work efficiency, and is more convenient for storage and loading and unloading.

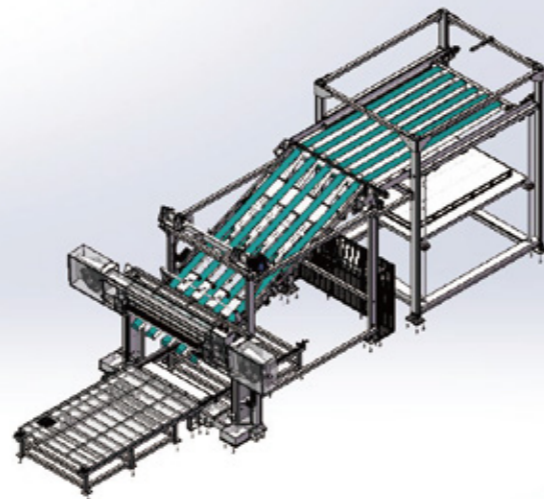

## 为客户创造更多价值

Create more value for customers



### 持续产品创新与服务改进

#### Continuous product innovation and service improvement

我们持续技术创新与不断改进, 为您提供海绵切割 / 海绵发泡 / 海绵打包 / 海绵再生等专业技术解决方案。

十余年来, 公司秉承不断改进提高永无止境的开发理念, 已荣获多项国家发明专利和实用新型专利证书。本公司研制生产的海绵切割机, 切割方式多样, 可切割不同幅面、不同厚度的材料, 切割精度高, 切口平滑, 可满足客户不同需求。

售后服务是企业发展的保障, 我们拥有专业的售后服务团队和完善的服务体系, 为客户提供现场布置、安装、调试、培训、保养等服务。只有脚踏实地, 精益求精, 诚心诚意为客户着想, 才能取得进步, 赢得市场。

Our continuous technological innovation and continuous improvement, to provide you with sponge cutting/sponge foam/sponge packaging/sponge regeneration and other professional technical solutions.

For more than ten years, the company has been adhering to the development concept of continuous improvement and improvement, and has won a number of national invention patents and utility model patent certificates. The sponge cutting machine developed and produced by the company has a variety of cutting methods, which can cut materials of different formats and different thicknesses, with high cutting accuracy and smooth incision, which can meet different needs of customers.

After-sales service is an important guarantee for the development of enterprises, we have a professional after-sales service team and perfect service system, to provide customers with on-site layout, installation, commissioning, training, maintenance and other services. Only by being down-to-earth, striving for excellence, and sincerely thinking of customers, can we make progress and win the market.

